

INDEX

- 2 GET TO KNOW YOUR MACHINE
- 2 THE CONTROL PANEL
- 3 INSTALLATION
- 4 PRECAUTIONS
- 5 WASHING
- 7 DRAINING
- 8 RINSING
- 11 SPIN DRYING
- 12 AFTER USE
- 13 MAINTENANCE
- 14 HELP
- 15 DEFY SERVICE CENTRES
- 16 WARRANTY
- 17 SPECIFICATIONS



You can rely on Defy

OWNER'S MANUAL



Twinmaid

1300

www.defy.co.za

Getting to know your machine

You are now the proud owner of one of the finest and most modern washing machines that today's technology can produce. You are going to make a great team together. But first it will pay if you really get to know each other. This book will tell you all you need to know about your machine, what it will do and how to do it. Please read all the instructions carefully before operating the machine .

The control panel

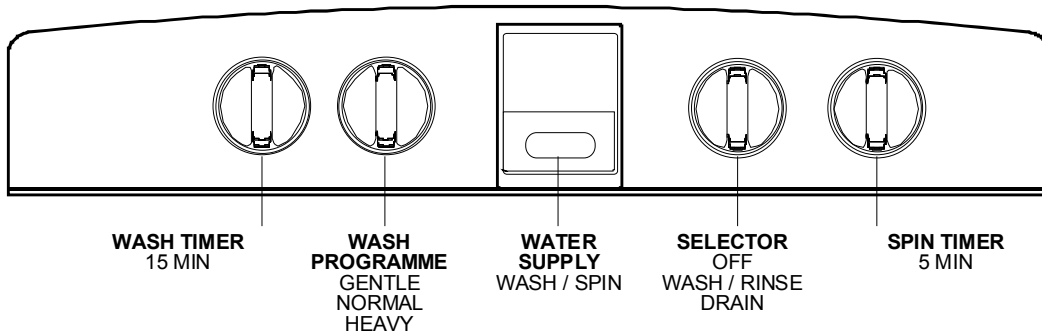

The wash and spin tubs

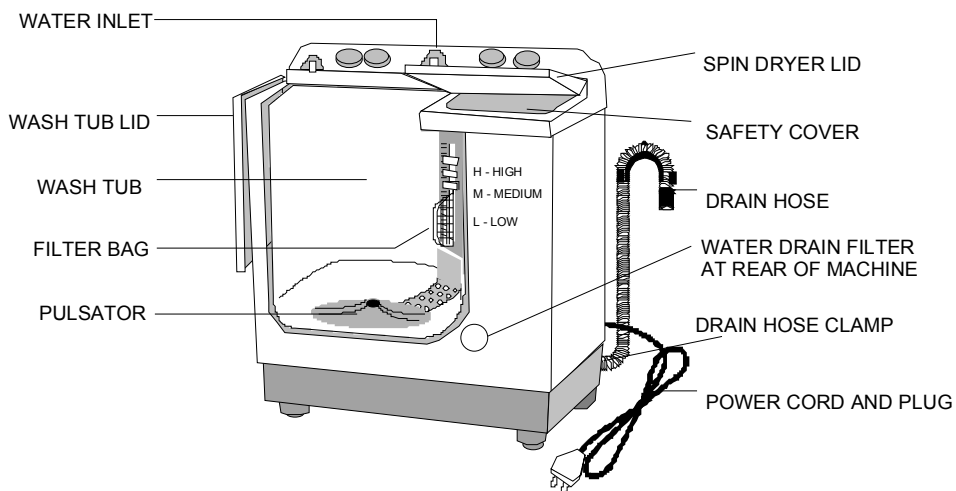

Accessories

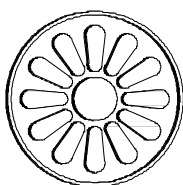

SPIN TUB
LID COVER

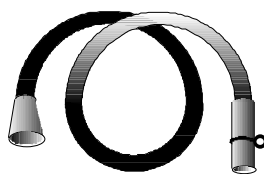

WATER SUPPLY
HOSE



DRAIN HOSE
AND CLAMP

INSTALLATION

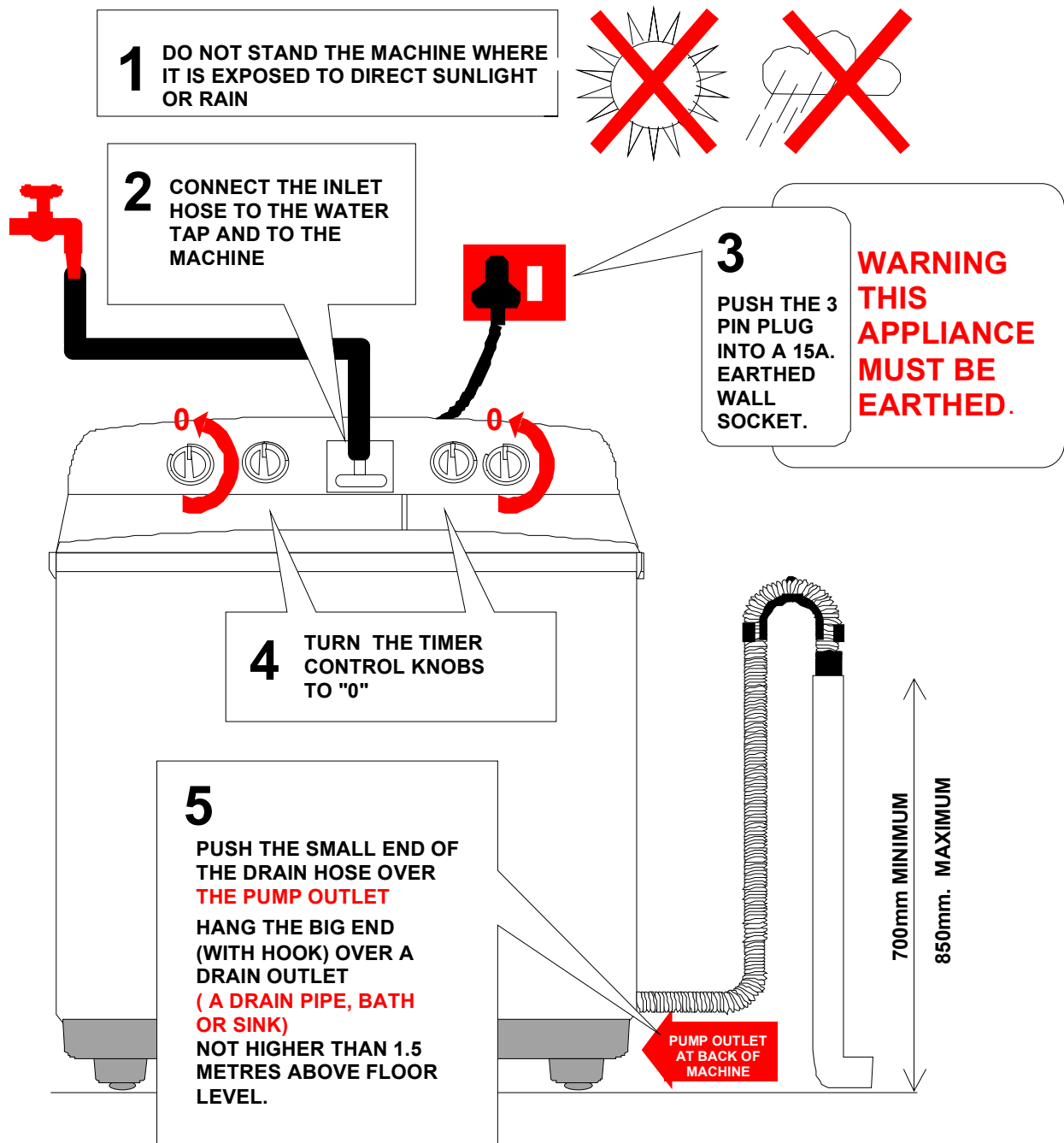

THE MACHINE MUST STAND ON A LEVEL SURFACE

PRECAUTIONS

1



DO NOT TOUCH THE SPIN DRUM WHEN IT IS ROTATING

2

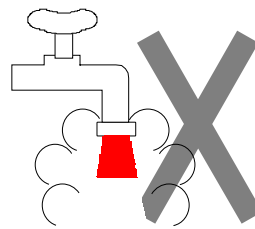

DO NOT USE WATER HOTTER THAN 55°C. VERY HOT WATER COULD DAMAGE PARTS OF THE MACHINE

3

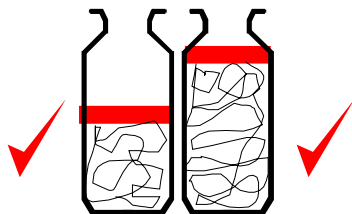

IMPORTANT

ALWAYS USE THE SPIN TUB DISC COVER AS THIS PREVENTS CLOTHING FROM RISING OUT OF THE SPIN TUB

4

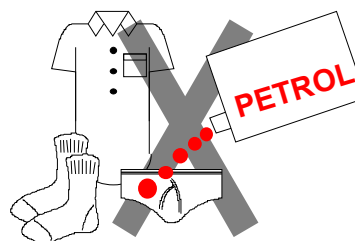

DO NOT MACHINE WASH CLOTHES SOAKED IN PETROL, THINNERS, PARAFFIN OR ANY OTHER FLAMMABLE LIQUIDS

5

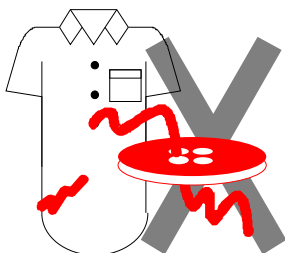

CHECK ALL CLOTHES FOR LOOSE BUTTONS AND TEARS
CHECK POCKETS FOR COINS, PINS ETC.

6

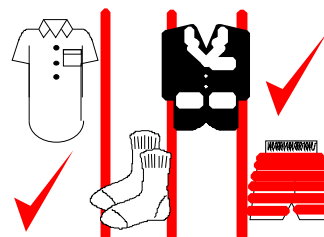

SORT AND SEPARATE CLOTHES BY FABRIC, COLOUR AND DEGREE OF DIRT

7

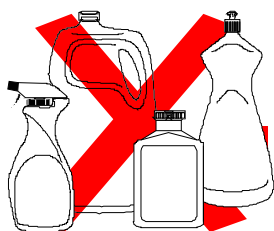

USE ONLY SOAP POWDERS SPECIALLY DESIGNED FOR TWIN TUB WASHING MACHINES

8

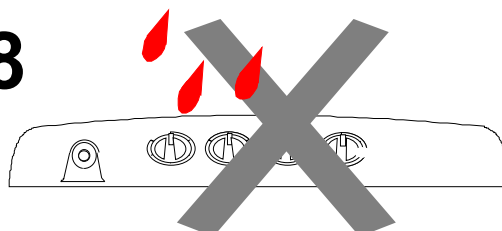

DO NOT SPLASH WATER OVER THE CONTROLS AS THIS COULD LEAD TO AN ELECTRICAL PROBLEM

IMPORTANT

NEVER TRY TO TURN A KNOB FURTHER THAN THE MARKING ON THE DIAL
TURN ANTI CLOCKWISE TO RETURN THE KNOB TO "0"

WASHING

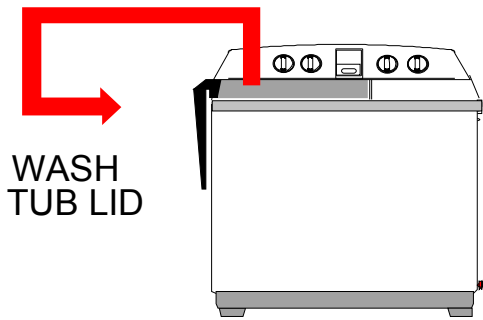

1 REMOVE WASH TUB LID AND HANG IT ON THE SIDE OF THE MACHINE

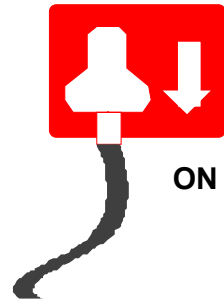

2 SWITCH ON THE POWER AT THE WALL SOCKET

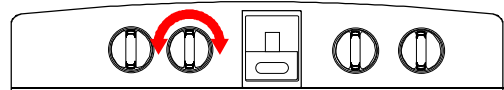

TURN THE WASH PROGRAMME KNOB TO GENTLE, NORMAL OR HEAVY WASH

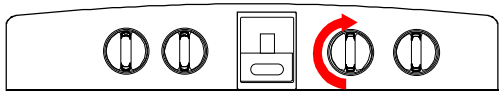

3 TURN THE SELECTOR KNOB TO WASH / RINSE

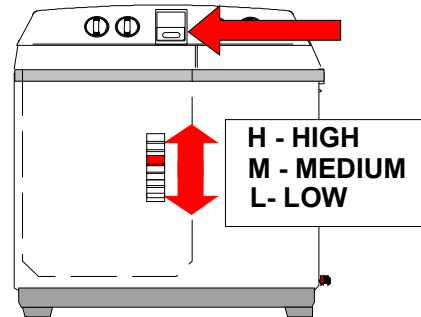

4 SLIDE WATER SELECTOR TO THE LEFT FOR WASH. SET DESIRED WATER LEVEL

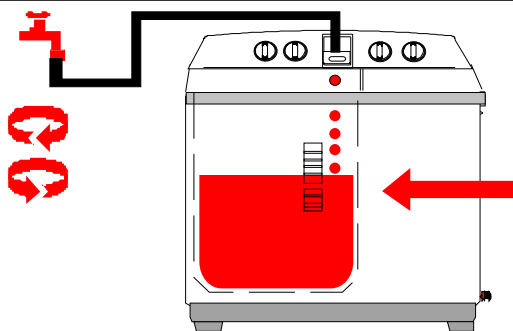

5 OPEN THE TAP AND FILL THE WASH TUB WITH WATER TO THE DESIRED WATER LEVEL. THEN CLOSE THE TAP.

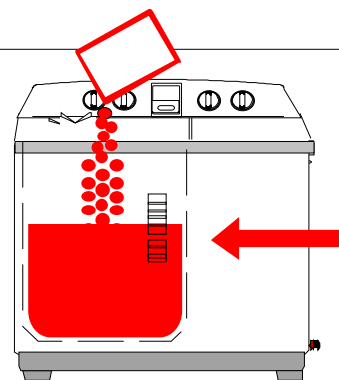

6 ADD SOAP POWDER AS DIRECTED. USE ONLY DETERGENT DESIGNED FOR TWIN TUB WASHING MACHINES.

WASHING Continued.



7 PLACE THE WASHING IN THE TUB
ONE ARTICLE AT A TIME

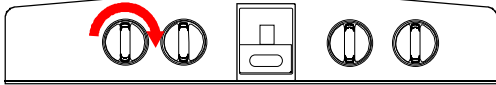

TURN THE WASH TIMER KNOB TO THE DESIRED TIME.

GENTLE WASH	- SYNTHETICS, WOOL, SILK	2-5 MIN
NORMAL WASH	- COTTON, LINEN	5-15 MIN
HEAVY WASH	- VERY DIRTY WASHING	9-15 MIN



9 THE WASHING MACHINE WILL START WASHING AS PER THE SELECTED TIME AND WASH PROGRAMME

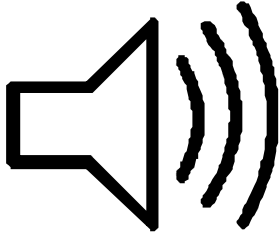

10 NOTE
15 SECONDS BEFORE COMPLETION OF THE WASH, AN ALARM BUZZER WILL SOUND TO REMIND THE USER THAT THE WASH CYCLE IS NEARLY COMPLETE

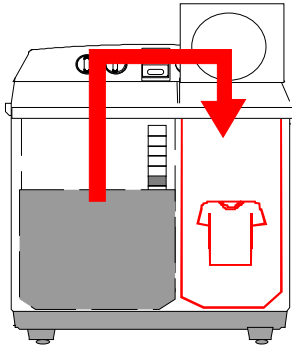

11 AFTER THE WASHING IS COMPLETE, REMOVE THE WASHING FROM THE WASH TUB AND PLACE IT IN THE SPIN DRUM

WARNING

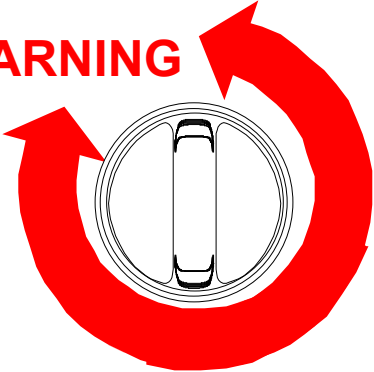

IMPORTANT
NEVER TURN A KNOB FURTHER THAN THE MARKING ON THE DIAL
TURN ANTI CLOCKWISE TO RETURN TO "0"

DRAINING

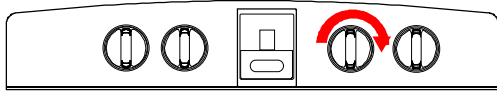

11

IF REQUIRED, ANOTHER LOAD MAY BE WASHED IN THE SAME SOAPY WATER. IF NOT, THE SELECTOR KNOB SHOULD BE TURNED TO DRAIN

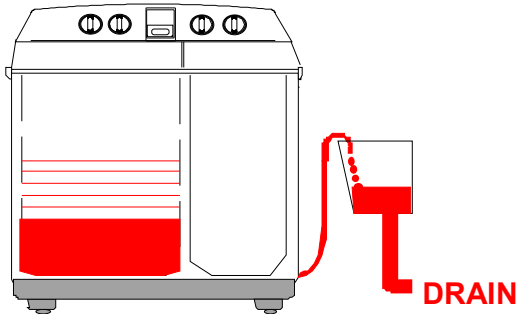

12 THE SOAPY WATER WILL DRAIN FROM THE MACHINE

WARNING

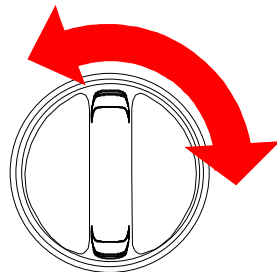

**IMPORTANT
NEVER TURN A KNOB
FURTHER THAN THE MARKING ON THE DIAL
TURN ANTI CLOCKWISE TO RETURN TO OFF**

RINSING

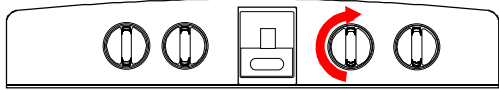

1 SET THE SELECTOR KNOB TO WASH / DRAIN

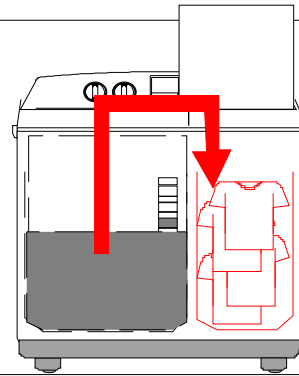

2 PLACE THE WET WASHING IN THE SPIN DRUM, DISTRIBUTING IT EVENLY

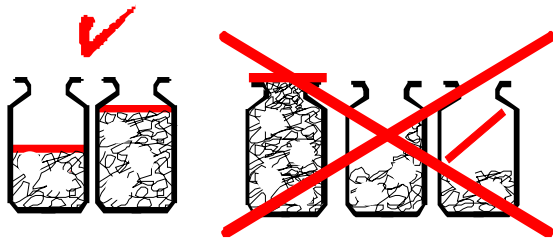

3 PUSH THE WASHING DOWN GENTLY INTO THE SPIN DRUM AND PLACE THE DISC COVER IN THE DRUM SO THAT IT COMPLETELY COVERS THE WASH LOAD

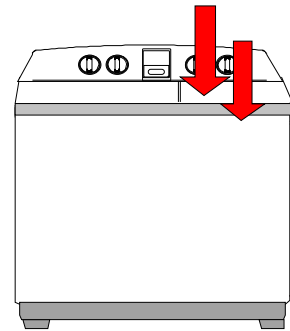

4 CLOSE BOTH SPIN TUB LIDS

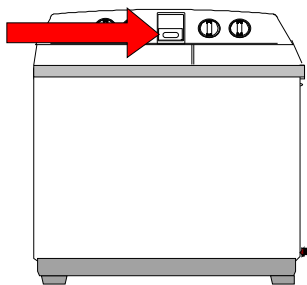

5 SLIDE WATER SELECTOR TO THE RIGHT FOR SPIN RINSE FOR WASH AND CLOSE BOTH SPIN DRUM LIDS.

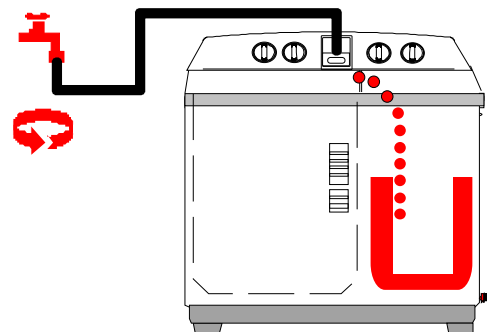

6 OPEN THE TAP TO SUPPLY AN APPROPRIATE FLOW OF WATER TO THE SPIN TUB

NOTE:

STEPS 5, 6 AND 8 (MARKED WITH A RED BORDER), ARE OPTIONAL
THEY ALLOW YOU TO SPIN / RINSE IF SO DESIRED.

SPIN / RINSING HELPS TO REMOVE SOAPY WATER MORE EFFICIENTLY

Rinsing continued

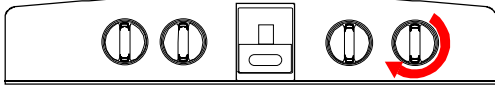

7 TURN THE SPIN TIMER KNOB TO THE DESIRED TIME

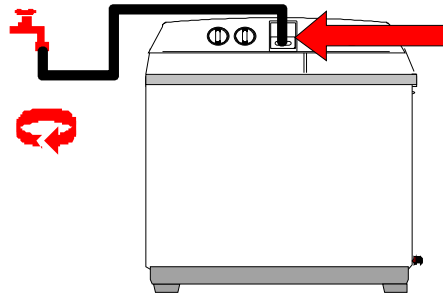

8 IF SPIN / RINSE WAS USED, CLOSE THE TAP AND SLIDE THE WATER SELECTOR LEVER TO THE LEFT

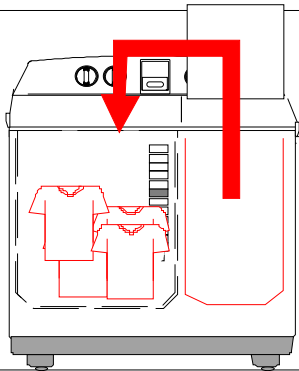

9 REMOVE THE WASH LOAD FROM THE SPIN DRUM AND PLACE IT IN THE EMPTY WASH TUB

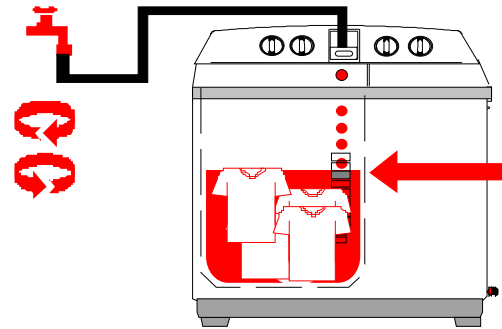

10 OPEN THE TAP AND FILL THE WASH TUB WITH WATER TO THE DESIRED WATER LEVEL. THEN CLOSE THE TAP.

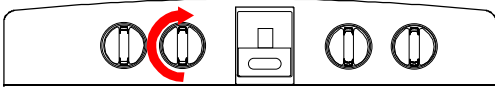

11 SET THE WASH PROGRAMME KNOB TO NORMAL

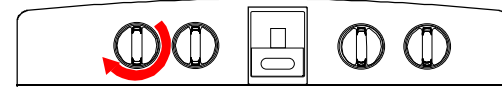

12 SET THE WASH TIMER KNOB TO THE REQUIRED RINSING TIME

DELICATE RINSE - SYNTHETICS, WOOL, SILK 2 - 5 MIN
 NORMAL RINSE - COTTON, LINEN 5 - 15 MIN
 HEAVY RINSE - HEAVY ROBUST FABRICS 9 - 15 MIN

Rinsing continued

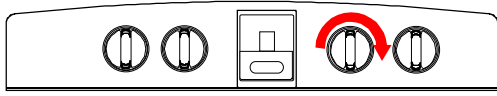

13 AFTER RINSING, TURN THE
SELECTOR KNOB TO DRAIN

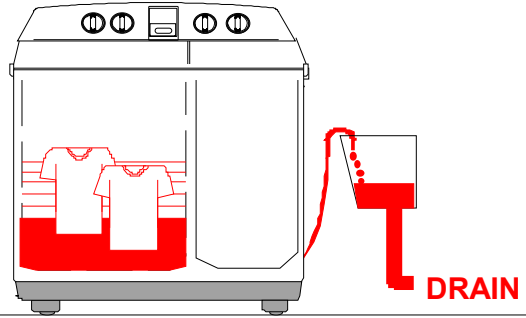

14 THE RINSE WATER DRAINS AWAY

SPIN DRYING

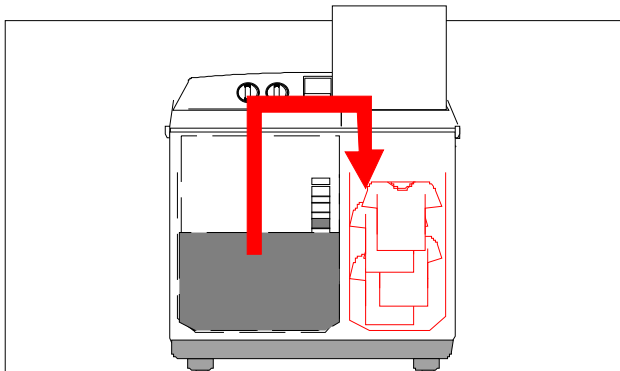

1 PLACE THE WET WASHING IN THE SPIN DRUM, DISTRIBUTING IT EVENLY



2 PUSH THE WASHING DOWN GENTLY INTO THE SPIN DRUM AND PLACE THE DISC COVER IN THE DRUM SO THAT IT COMPLETELY COVERS THE WASH LOAD

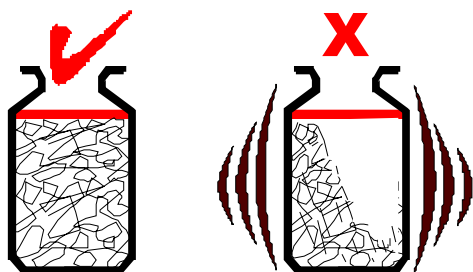

3 **CAUTION**
EVENLY DISTRIBUTE WET WASHING IN THE SPIN DRUM. AN OUT OF BALANCE LOAD COULD DAMAGE THE SPIN TUB.

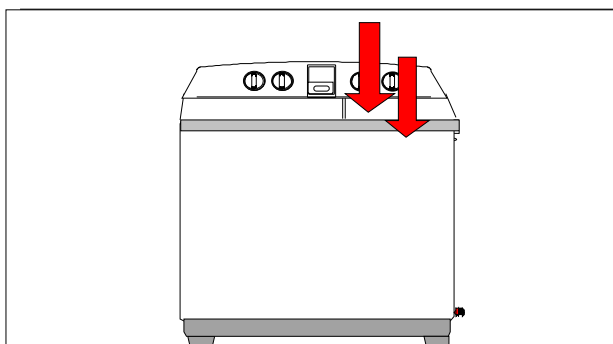

4 CLOSE BOTH SPIN TUB LIDS

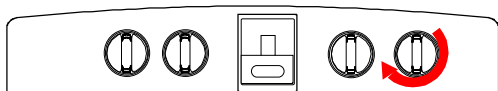

5 TURN THE SPIN TIMER KNOB TO THE REQUIRED SPINTIME

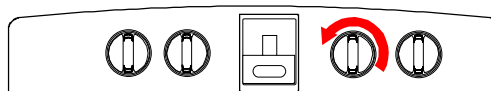

6 AT THE END OF THE SPIN CYCLE, TURN THE SELECTOR KNOB TO OFF

7 REMOVE THE LAUNDRY

NOTE:

RECOMMENDED SPIN TIMES ARE:

DELICATE FABRICS = 1 MINUTE

WHITES COTTON AND LINNEN = 2 TO 4 MINUTES

HEAVY COTTON FABRICS = 3 TO 5 MINUTES

AFTER USE

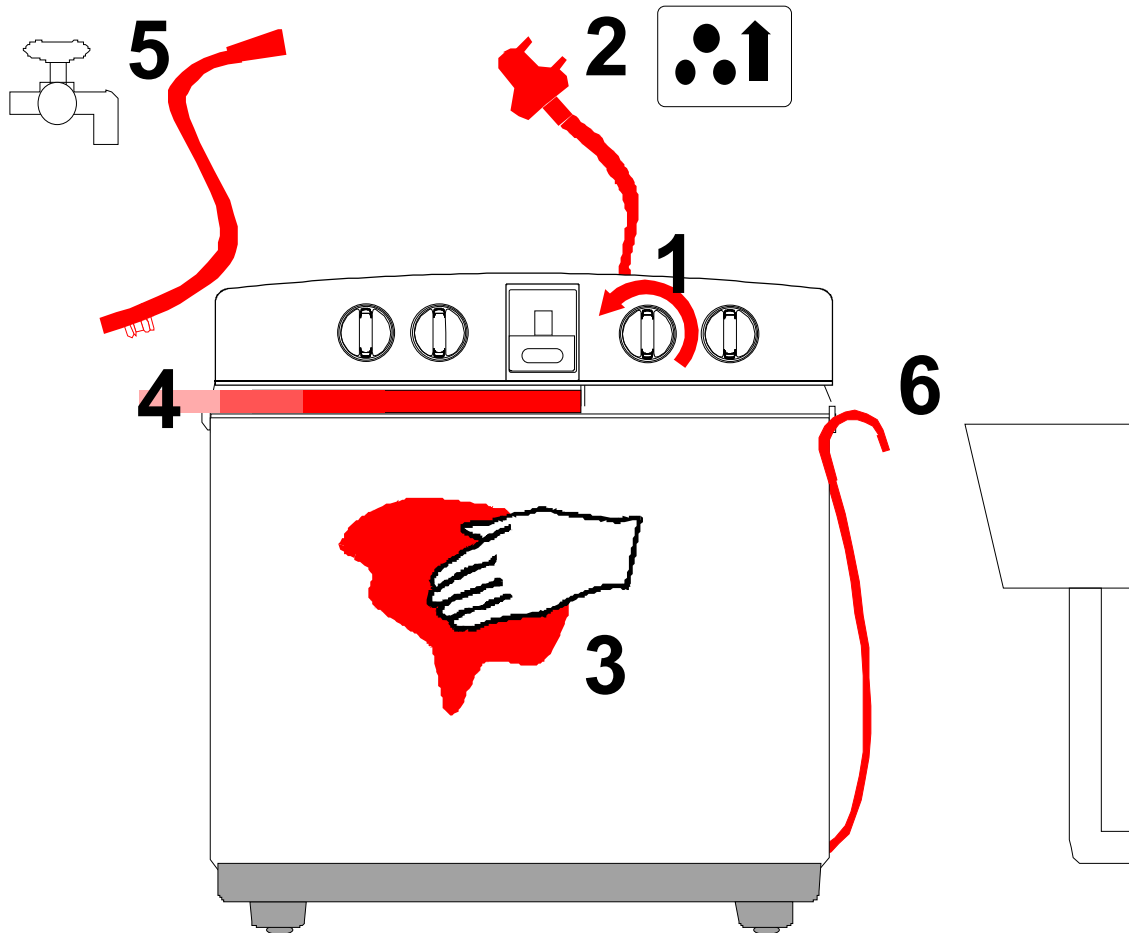

NEVER TOUCH THE ELECTRICAL PLUG OR SOCKET WITH WET HANDS

- 1 TURN THE SELECTOR KNOB TO OFF
- 2 SWITCH THE POWER OFF AT THE WALL SOCKET AND REMOVE THE PLUG FROM THE SOCKET.
- 3 DRY THE CABINET, THE CONTROL PANEL AND INSIDE THE TUBS WITH A SOFT, LINT FREE CLOTH.
- 4 PLACE THE WASH TUB LID IN POSITION OVER THE WASH TUB.
- 5 IF YOU WISH TO MOVE THE MACHINE, FIRST UNCOUPLE THE INLET HOSE FROM BOTH THE TAP AND THE MACHINE.
- 6 REMOVE THE OUTLET HOSE FROM THE DRAIN BUT DO NOT DETACH THE OUTLET HOSE FROM THE MACHINE.

MAINTENANCE



CLEANING THE LINT FILTER

PERIODICALLY, THE FILTER BAG REQUIRES CLEANING. PRESS THE CATCH DOWNWARDS AND PULL THE FILTER OUT. RINSE CLEAN UNDER RUNNING WATER AND REPLACE.

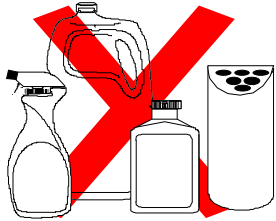

CLEANING THE CABINET

WIPE THE CABINET WITH A DAMP SOAPY CLOTH. RINSE AND WIPE DRY.

DO NOT USE HOUSEHOLD CLEANERS, ABRASIVES OR VOLATILE LIQUID CLEANERS

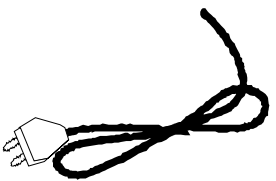

IMPORTANT

IF THE POWER CORD SHOULD EVER NEED REPLACING, USE ONLY A GENUINE REPLACEMENT PART AVAILABLE FROM DEFY SERVICE CENTRES

CLEANING THE FILTER

REGULARLY CLEAN THE DRAIN FILTER, LOCATED AT THE REAR OF THE MACHINE

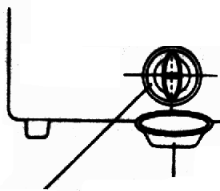

Place a shallow container under drain to collect any residual spillage

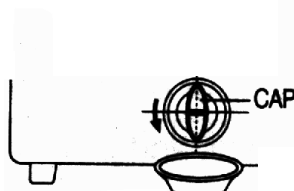

Turn the filter cap in an anticlockwise direction

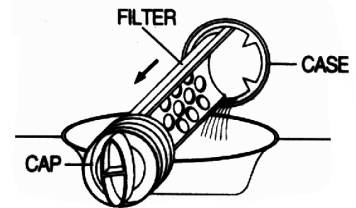

Pull the filter assembly out.

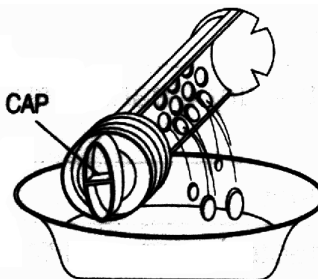

Clean the drain filter.

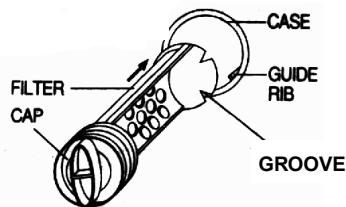

Re-fit the filter guides ensuring that the groove in the filter aligns with the guide rib

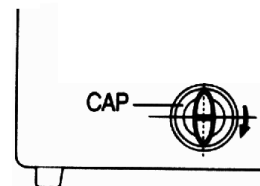

Tighten the cap by turning in a clockwise direction

HELP

IF YOUR MACHINE WILL NOT WORK,
CHECK THE FOLLOWING BEFORE CALLING A SERVICE TECHNICIAN

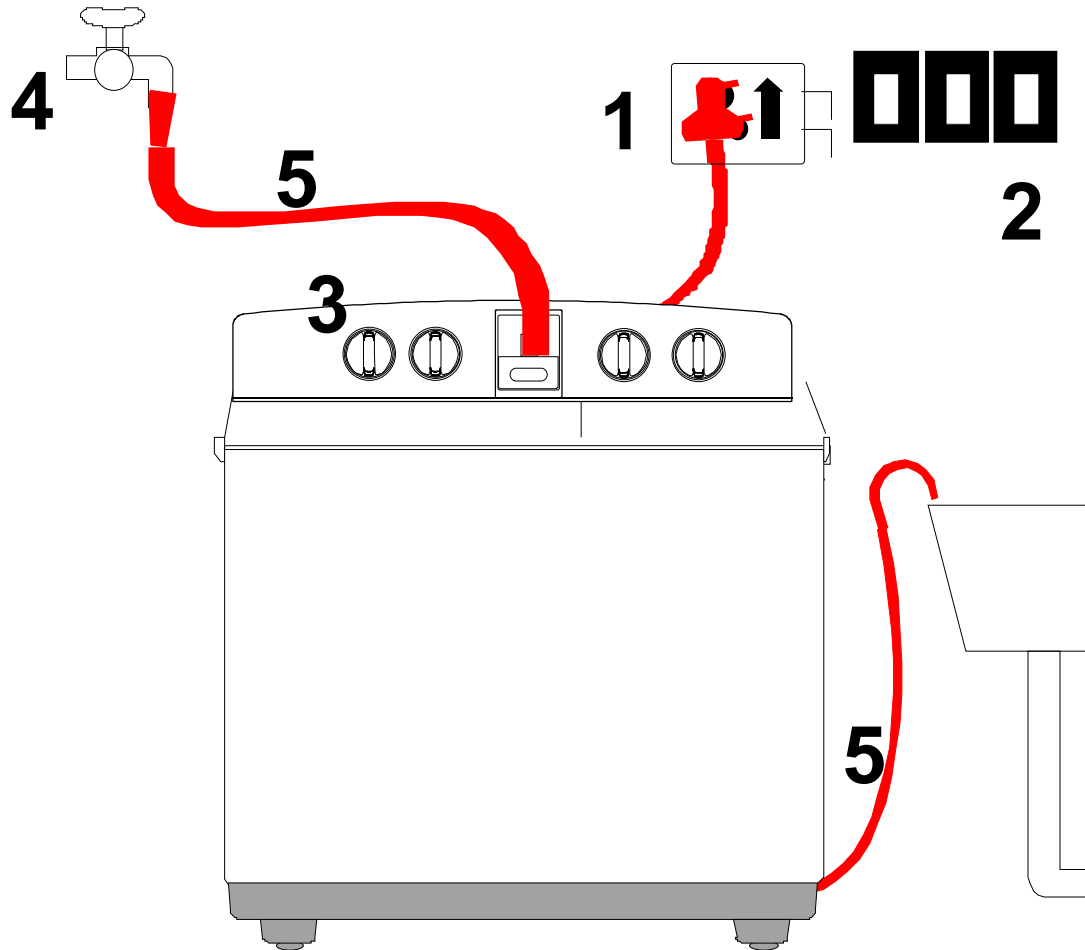

- 2 HAS A HOUSE FUSE BLOWN OR HAS A CIRCUIT BREAKER TRIPPED?
- 3 ARE THE CONTROL KNOBS IN THE CORRECT POSITION?
- 4 HAS THE WATER TAP BEEN TURNED OPEN?
- 5 HAS AN INLET OR OUTLET HOSE BEEN KINKED, TWISTED OR BENT?
- 6 HAVE THE FILTERS BEEN CLEANED?
- 7 CHECK FOR CLOTHES ENTANGLED ROUND THE SPIN DRUM.
- 8 HAS THE SPIN TUB LID BEEN CLOSED PROPERLY?

IF YOU HAVE FOLLOWED THE INSTRUCTIONS AND STILL HAVE A PROBLEM,
CONTACT THE NEAREST DEFY SERVICE CENTRE.
THEY WILL BE ABLE TO HELP OR SEND A FACTORY TRAINED TECHNICIAN
TO ASSIST YOU.

Service Centres

If you have followed the instructions and still have a problem, contact the nearest Defy Service Centre. They will be able to advise you on any aspect of the product or send a qualified technician to repair it.

BLOEMFONTEIN 160 Long Street, Hilton,
Bloemfontein 9301.
Tel. 051 400 3900
Bloemfontein.Service@defy.co.za

CAPE TOWN 5A Marconi Rd.
Montague Gardens, 7441.
Tel. 021 551 8314
CapeTown.Service@defy.co.za

DURBAN 35 Intersite Avenue,
Umgeni Business Park, Durban 4051.
Tel. 031 268 3300
Durban.Service@defy.co.za

EAST LONDON 16 Bowls Rd. Arcadia,
East London 5201.
Tel. 043 743 7100
EastLondon.Service@defy.co.za

JOHANNESBURG Cnr. Mimetes & Kruger Sts. Denver ext.12
Commercial Head Office,
Administration, Distribution, National Groups,
Tel. Sales, Contracts and Credit.
Johannesburg. 2094.
Tel. 011 621 0200 or 011 621 0300
Gauteng.Service@defy.co.za

POLOKWANE 87 Nelson Mandela Drive.
Superbia 0699.
Tel. 0152 92 1166 / 7 / 8 / 9.
Polokwane.Service@defy.co.za

PORT ELIZABETH 112 Patterson Road,
North End, Port Elizabeth 6001.
Tel. 041 401 6400
PortElizabeth.Service@defy.co.za

PRETORIA. Block A1 Old Mutual Industrial Park.
Cnr. D.F.Malan Drive & Moot Str.
Hermanstad. 0082.
Tel. 012 377 0061
Pretoria.Service@defy.co.za

**OTHER AREAS ARE SERVICED BY OVER 200 AUTHORISED SERVICE AGENTS.
PLEASE CONSULT THE NEAREST REGIONAL DEFY SERVICE CENTRE FOR DETAILS.**

Warranty

This certificate is issued by DEFY APPLIANCES (PTY) LIMITED manufacturers of Defy and Ocean products, hereinafter the Company, to the original purchaser only, of the appliance described on the certificate and shall constitute the only warranty given in respect of this appliance.

The Company warrants to the original purchaser that for a period of ONE YEAR from date of purchase the appliance is free from defect under normal domestic use, both in workmanship and material, subject to the following conditions.

1. Repair or replacement of any part of this appliance, found by the Company to be defective, shall be at the election of the Company. The Company reserves the right to effect such service through any of its Service Divisions or Authorised Service Dealers. The cost of such service shall be borne by the Company in full, provided that the appliance is located no further than 50km from a Company Service Centre or an Authorised Service Dealer. Where the appliance is located beyond the 50km radius, the purchaser shall be liable for the standard travelling charges, as determined by the Company.

CARRY IN SERVICE Microwave ovens, Compact cookers and small appliances are repaired in our service centres and are not collected from the customers home. Faulty units should be delivered to the purchasing dealer or to the nearest Company Service Centre for warranty repairs.

2. Vitreous enamelware, fuses and lamps are specifically excluded from these warranties. It is an express condition of these warranties that the purchaser takes due care and attention in the use and maintenance of the appliance. Abuse, misuse in conflict with operating instructions, connection to incorrect voltages and subjection to commercial use shall release the Company from its obligations.

3. This warranty shall become void and cease to operate if the appliance is dismantled by, or any repairs to the appliance are effected by any persons not duly authorised by the Company, or if substitute parts not approved by the Company are used in the appliance, or if the serial number of the appliance is removed.

4. The Company shall not be responsible for damages resulting from fire, flood, civil disturbances or any Act of God. The Company shall not, in terms of these warranties be responsible nor held liable for any consequential loss or damage of any kind caused by or due to the failure or malfunction of the appliance.

5. The Company shall not be responsible for transportation or other costs other than those incurred within the provisions of Point 1 of this Certificate.

6. These warranties shall not apply to the appliance if it is purchased or used beyond the borders of the Republic of South Africa, Namibia, Botswana, Swaziland and Lesotho.

7. Where service is requested under warranty and no fault or defect can be found by the Company, all costs incurred will be for the purchaser's account.

8. This Certificate as well as your invoice will serve as proof of purchase. For the purpose of warranty, it will be essential to produce this Certificate and invoice. Failure to do so, will render the purchaser liable for service costs.

**KEEP THIS CERTIFICATE AND SALES INVOICE AS PROOF OF
PURCHASE FOR WARRANTY PURPOSES.**

OWNER'S MANUAL

SPECIFICATIONS

POWER SOURCE AC 230 V
FREQUENCY 50Hz

POWER CONSUMPTION
WASH MOTOR 400W
SPIN MOTOR 180W
PUMP 30W

EXTERNAL DIMENSIONS
HEIGHT 1010mm.
WIDTH 880mm.
DEPTH 540mm.

NETT WEIGHT 40.5 Kg.

WATER CAPACITY
HIGH 72 LITRES
MEDIUM 63 LITRES
LOW 54 LITRES

CAPACITY 9kg

MAINS CABLE TYPE Y



You can rely on Defy



TWINMAID 920

The Manufacturer strives for continuous improvements.

For this reason, the text and illustrations in this book are subject to change without notice.